

Installation & Operating Manual

Please read this manual carefully before attempting to install, operate or maintain the product described. Failure to comply with the information provided in this manual could result in personal injury and/or property damage. Retain this manual for future reference.

LAING Seal-less Centrifugal Canned Motor Pumps

For Instant Hot Water Recirculating Systems

Models: SM-303-B
SMT-303-B
SM-909-B-14
SMT-909-B-14
UC-303-B
UCT-303-B

SM-303-B



SMT-303-B



with 24 hour timer

SM-909-B-14



SMT-909-B-14



with 24 hour timer

UC-303-B



UCT-303-B

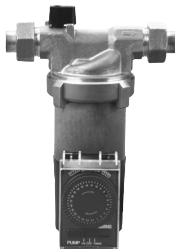

with 24
hour timer

About LAING Pumps

Laing Recirc® pumps have only one moving part--the rotor/impeller. The motor creates an electromagnetic field that balances and spins the rotor/impeller on a stationary bearing ball inside the pump cavity. The motor is fully encapsulated in resin, has no moving shafts or seals, and eliminates conventional wear that can generate noise. Like all seal-less centrifugal circulators, the pump cannot be run without water lubricating the bearing. The pump housing must be flooded before start-up and water must be maintained in the system during pump operation. The unique leak-proof integration of the motor and pump housing eliminates the need for conventional mechanical seals or other shaft sealing devices. These components are self-lubricating and require no external lubrication.

WARRANTY

Laing recirculation pumps are warranted against defects in materials and workmanship for 24 months from the date of manufacture (see mfg. date label on pump) or twelve (12) months from date of user purchase, with proof of purchase, whichever is later. In order to receive warranty considerations, the product must be returned prepaid to the company from which it was originally purchased. If the pump is found defective, the pump will be replaced or in the case of wholesale customers, appropriate purchase credit will be issued. Prior to returning any defective pump to Laing for warranty consideration, contact the Laing factory for an RMA tracking number. Any claim for consequential damages resulting from a pump malfunction is not covered by the Laing warranty. Additional warranty details are available on request. (1/02)

About Recirculation Systems

Air in the System: A properly installed system should include a method of automatically venting the air that enters the water supply line during use. Air enters the system each time fresh, cold water is introduced into the hot water heater. Air may also enter the system any time a plumbing line is opened, for instance during a faucet change or adding a sprinkler system.

Water Pressure: A recirculating system is a pressurized system operating at the city water pressure, as determined by the pressure regulator on your line, or by a well pump, if you are on a well system. In most residential plumbing systems, water pressure is set at 35 psi and above. Below 35 psi, water pressure may not be sufficient to fill the pipe diameter, leaving space for air to accumulate in the lines. If your system pressure is less than 35 psi, use the next larger pump on the Pump Selection Guide.

Multiple Floors: Because the system is pressurized, the number of floors in a home is not taken into consideration in sizing the circulating pump. The pump has only to produce continuous flow at a pressure sufficient to overcome the friction losses created by the piping in the house water supply line and the return line.

Oversized Pumps: Pumps should not be so large as to produce flow rates that may eventually erode holes in the pipes. According to the Copper Development Association, excessive erosion occurs at a velocity of about 5 ft. per second and higher; or about 4 GPM in 1/2" Type M copper pipe; and 8 GPM in 3/4" pipe. Use the recommended recirculation line size shown in the Pump Selection Guide. Laing pumps are sized so that flow velocities are well below these limits.

Pump Selection Guide: The Laing SM and UC 303 models are designed to handle the recirculation requirements of residences with a pipe loop (the total length of hot water supply line plus the recirculation line) up to 250 feet while the SM-909 model pump is designed to handle the circulation requirements of residences and small apartment complexes with pipe loop runs to 700 or 1000 feet. The chart below provides a simple rule of thumb to help you match the pump to your system.

About Plastic Piping

In many cities throughout the U.S. Polybutylene and CPVC plastic piping is approved for use in residential water systems for both hot and cold water supply lines. However, it is not clear as to the plastic pipe manufacturer's position relative to the approved use of their pipe when there is always hot water in the hot water lines such as would be the case with a hot water recirculation system. Evidently having hot water in the lines intermittently is acceptable (timer operated pump) but not constantly. As a result Laing cannot offer any recommendations for or against the use of plastic pipe until such time as the plastic pipe manufacturers themselves establish a clear position in this regard. Check your local codes on the permissibility of plastic piping for your hot water recirculation system.

Pump Selection Guide

Pump Model	Building Size	Total Pipe Loop (Supply & Return)	Recirc Line Pipe Size
SM/SMT-303 (BS 1/2" or BT 1/2"), UC/UCT-303,	Residential	250 ft.	1/2"
SM/SMT-909-B-14 (BS 1/2" or BS 3/4"), UC/UCT-909-14	Residential	700 ft.	1/2" or 3/4"
SM/SMT-909-B-18, SM/SMT-909-B-26 (BS 3/4" or BF), UC/UCT-909-18, UC/UCT-909-26	Residential	1000 ft.	3/4"

Pump Data

Model	HP	RPM	Watt	Volt	Phase	Cycle	Amps
SM/SMT-303, UC/UCT-303	1/150	3400	33	115	1	60	0.3
SM/SMT-909-14, UC/UCT-909-14	1/50	3400	65	115	1	60	0.6
SM/SMT-909-18, UC/UCT-909-18 SM/SMT-909-26, UC/UCT-909-26	1/20	3400	98	115	1	60	0.9

Housing Codes:

BS 1/2 - 1/2" Sweat
 BT 1/2 - 1/2" Female NPT
 BS 3/4 - 3/4" Sweat
 BF - Flanged

Installation and Start Up

1. **Select the sink under which to connect the recirculation line** (the sink where the hot water takes longest to arrive which is usually the sink farthest from the water heater).
2. **Plan your installation.** Decide on the course of the recirculation pipe (also determining the length of the pipe required) and whether the return line should be connected to the water heater cold water inlet line (tee fitting required) or to the bottom water heater drain valve ("Y" type fitting required). See figure 1 and 2 for the installation schematic.

UC/UCT Models

A. Return into Cold Water Line at Top of Water Heater fig. 1

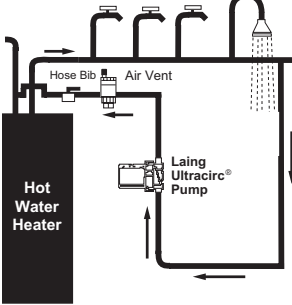

B. Return to Drain Valve at Bottom of Water Heater fig. 2

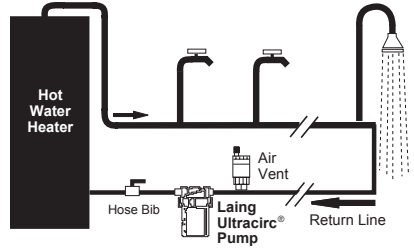

SM/SMT Models

A. Return into Cold Water Line at Top of Water Heater fig. 3

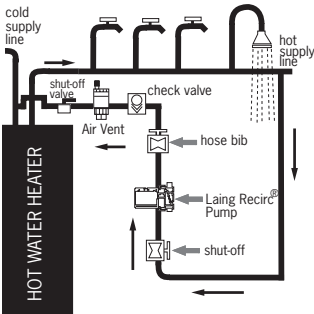

B. Return to Drain Valve at Bottom of Water Heater fig. 4

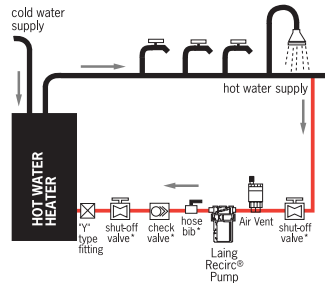

Note: provide upward slope of piping from the pump to the water heater.

Above diagrams are for single line returns only. For multiple branched supply line installations, a recirculation line should be installed for each branch.

Note: The pump must always be installed below the water level of water heater so that the pump flow is always upward or directly horizontal and not downward. Do not mount the pump above the water heater.

3. Purchase materials required.

- Laing Recirc® Pump (SM-303/UC-303 or SM-909)
- (1) 1/2" or 3/4" swing check valve (not required on UC/UCT models)
- Copper pipe or tubing
- (1) 1/2" or 3/4" hose bib
- Tee for under sink connect
- (1) Auto air vent
- Tee or "Y" fitting connection to water heater
- Misc. nipples and fittings
- (2) 1/2" or 3/4" shut-off valves (not required on UC/UCT models)
- Pipe insulation

4. Shut off the water to the house.

5. **Drain the plumbing lines** by opening the faucets in the house. Drain the water heater if you plan to make the connection at the bottom of the water heater, which requires removal of the drain valve.

6. **Connect the return line at the last faucet riser and run to the water heater.** Tee the return line as close to the end of the hot water supply line as possible and run the return line back to the water heater.

7. **Install the pump and other components required** in accordance with the diagrams provided in fig. 1 or 2 and connect the return line to the water heater (also see fig. 3).

For SM(T) and UC(T) 303 Models
Check pump operation before you begin. Unscrew the pump housing from the motor (fig. 4) and run the pump for a few seconds to make sure it is operational. Remove the rotor (see fig. 5) and add a little water to the bearing ball for lubrication. Do not use grease or oil to lubricate the pump.

Fig. 4
Remove the motor unit and o-ring from the pump housing into the plumbing line. Do not sweat the housing into the plumbing line with the motor or o-ring attached. Arrows on the pump housing indicate the direction of water flow.



Caution: Only hand tighten the screw ring. Do not over tighten! Do not use plumbers putty on the screw ring.

Ultracirc Models

The UC and UCT-303 models incorporate a shut off valve and check valve into the brass pump housing eliminating the need to install these components.

These models are supplied with 1/2" union fittings. These fittings should be removed from the pump housing before soldering to avoid damaging the internal valves.

Fig. 5

303-Models - Rotor/Impeller Installation: To remove the rotor unit, grasp the top of the unit and gently pull straight up. Do not pull up on one side only or push the rotor sideways. If the rotor sits too tightly, carefully lever it off with a screwdriver on each side of the rotor. When re-installing the rotor, use enough force to hear the rotor "click" on to the ceramic bearing and spin the rotor with your fingers to insure that it turns freely.

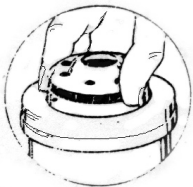

Remove the Rotor/Impeller by using forefinger and thumb and pulling upward.

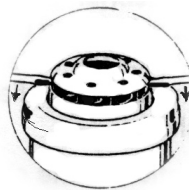

Or, if the Rotor/Impeller cannot be removed using forefinger and thumb, carefully lever off evenly with two screwdrivers.

For SM(T) - 909 Models

This unit may be installed into the pipe system without disassembling the pump. However, it is recommended that the motor section be disassembled from the pump housing by removing the two pump housing screws so that the system may be flushed as noted in paragraph 9.

Shut-Off Valve (allows isolation of water in the tank in the event of pump servicing).

Hose Bib (allows venting of air from system at start-up).

Auto Air Vent (allows continuous venting of air bubbles that intrude into all hot water circulating systems during operation).

Pump Mounting Positions fig. 3

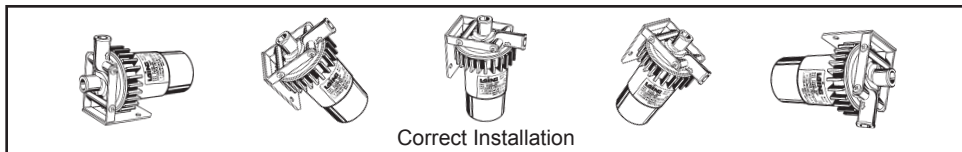

8. Close the shut-off valve on the inlet side of the pump and turn the water supply to the house back on.

9. Flush system of debris. Before reattaching the pump motor, open the shut-off valve on the inlet side of the pump housing and let water flow through the housing. Use a bucket to catch the water. Let the water run long enough to clear all sand, solder pellets, plumbers tape flakes, etc. from the lines. Close the inlet shut-off valve when finished.

10. Connect the pump motor to the housing. Make sure the rubber o-ring is in place in the housing and the screw ring is securely hand tightened (for 303 models) or that the top housing screws are firmly in place and tightened (909 models). **Reopen the shut-off valve or valves and let the water flood the pump housing.**

11. Purge air from the supply line. Turn on the faucet or shower farthest from the water heater. Open the line until you get a good, steady stream of water without sputter or evidence of air.

12. Purge air from the return line. Connect the pump to the electrical supply. With the pump running, open the hose bib and let water run until the pump is running quietly and there is no sputtering or other evidence of air coming from the hose bib. Close the hose bib. Your system is now in operation. Allow a few minutes for instant hot water to recirculate to all of your faucets.

SAFETY PRECAUTION: Remove the handle from the hose bib(s) to prevent a small child from mistaking it for a cold water faucet.

Insulating both the hot water supply and recirculation lines is strongly recommended.

13. If you have an SMT or UCT timer pump, set your timer in accordance with the instructions on the following page.

U.L. Caution

This pump has been tested using water only. Its suitability for use with liquids other than water is the end user's responsibility.

Timer Controlled Operation

If timer controlled operation is desired, the timer may be programmed to allow the Autocirc to operate during the hours desired (i.e. "ON" from 7:00 a.m. to 9:00 p.m. and "OFF" from 9:00 p.m. to 7:00 a.m.) as follows:

- Open timer cover and rotate the dial clockwise until the correct time is aligned with the pointer (▶) on the right side (3 o'clock position) of the dial. A timer instruction label affixed to the right side of the timer housing also shows this time setting point.
- Automatic Operation: PULL the tabs Upward on timer for the desired operating period of time. Example: If the desired operating time is 7:00 a.m. to 9:00 a.m., all tabs should be Pulled out between 7 and 9. NOTE: The timer may be set for multiple operating periods of time.
- Slide the switch bar to "timer".

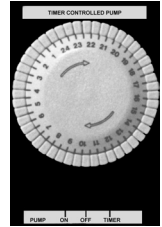

30 Min. Tabs

The timer mode will provide the most cost effective method of operation and can be programmed to run only during the time periods when hot water is most frequently required. Even during controlled timer operation, the Autocirc will only turn on when the built-in thermostat senses that additional hot water is required at the point of installation.

Do's and Do Not's

Do

- install an air vent mounted in a vertical position (if provided).
- use 1/2" recirculation line tubing.
- check to be sure there are no crimps or sharp bends in the recirculation line that would restrict the flow.
- be sure the check valve is installed in the proper direction of the flow.
- be sure all air is purged from the system prior to starting the pump.
- use a water conditioner if you have hard water.
- be sure the gate valves are open before turning on the pump.
- install the pump pumping in upward direction only.

Do Not

- use grease or oil to lubricate the pump - it is self-lubricating.
- over tighten the screw ring (SM-303 models).
- install the pump with the motor above the pump housing.
- install the pump pumping away from the water heater nor pumping downward.
- start the pump before the system is full of water and purged of air.
- allow the water heater temperature above 140°F.
- install the pump in the supply line to faucets.
- use any pipe size other than 1/2" for SM-303 or UC-303 models.
- position the pump at the top of the water heater.

Notes:

Keep The Hot Water Temperature Below 140°F: Higher temperatures can cause calcium and magnesium elements to come out of solution and create solids which could not only cause damage to the pump but also reduce water heater efficiency and premature failure of the water heater.

Hard Water Conditions: Use a water conditioner. Hard water can cause scale build-up and eventually reduce the life of the pump and other system components.

**Protected by one or more of the following Patents:
4580335, 4615662, 4822256, 4834628,
5094593, 5143049, 5749715, 6149407, 6227235**

Standard Dry Run Thermostat Operation

Each SM(T)-303 and UC(T)-303 model pump has a built-in 200°F thermal cut-off in order to protect against overheating, which could cause damage to the pump motor. In the event that disruption of your immediate hot water supply is noticed it is possible that the pump has or is running dry and the internal dry run thermal protector has shut down the pump motor. In this event, it is important that the dry run condition be corrected (otherwise the pump will fail prematurely) by following the procedure below:

1. Disconnect power to the pump motor.
2. Close the shut-off valves on each side of the pump.
3. Remove the pump motor/rotor assembly from the pump housing.
4. Dry off the pump motor/rotor assembly. Remove the rotor and check for any calcium build-up, foreign matter or any signs of wear. If these signs are not present, put the rotor back in place on the ceramic ball.
5. Hold the pump motor/rotor assembly upright and plug in the unit for about 10 seconds to see if the rotor spins evenly and quietly. If the motor does not go on, allow a few more minutes for the thermostat to reset as the unit cools down.
6. If the rotor spins properly, unplug the motor and reinstall the assembly into the pump housing.
7. Turn both shut-off valves to the on position, reconnect the electrical supply to the pump motor, and be sure that air is properly purged from your system.

130°F On-Off Thermostat Option "C"

Pumps with the letter "C" in the model are provided with a factory option "C" internal thermal cut-off which automatically shuts the pump down when the temperature of the water passing through the pump housing reaches 130°F +/- 10°F and turns the pump on at 110°F +/- 10°F (SM/SMT 909-14 only).

Variable Setting On-Off Thermostat Option "R"

Pumps with the letter "R" in the model designation are provided with a factory installed internal thermal cut-off with an adjustable On-Off temperature dial located on the outside of the motor. This dial can be rotated by placing a thin screw driver in the dial slot which allows the pump to turn off automatically when the water temperature passing through the pump housing reaches the dial setting selected-between 95°F and 140°F. The pump will turn back on automatically when the water temperature cools down to 10°F below the set temperature (SM/SMT-303 only).

System Maintenance

- Do not attempt to lubricate the pump. The pump is self-lubricating.
- Prevent the pump from running dry.
- Flush the system of any debris and re-purge all air from the system in the event of any water supply interruptions in plumbing line.
- Prevent heavy scale build-up by keeping the hot water temperature 140°F or less.
- Don't over salt your water conditioner.

Replacement Parts

Please provide the following information

- when ordering:
- Model number
 - Serial number
 - Part description

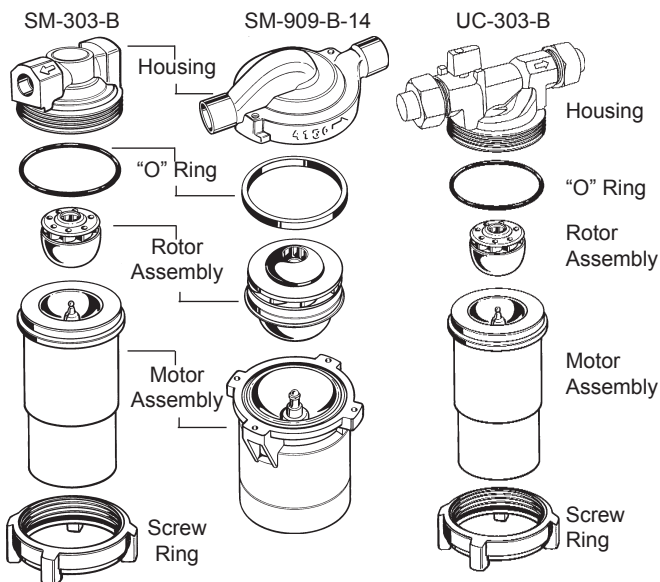

Trouble Shooting

Noise in the System: The pump should be virtually noiseless during operation. The rotor may make a brief but hardly perceptible fluttering noise immediately after the pump is turned off. During normal operation, an occasional air bubble may pass through the pump housing causing a momentary gurgling noise. However, if noise at the pump persists for any prolonged period, correct the problem (see below).

- The check valve is mistakenly installed on the inlet side of pump or in the wrong direction.
- The inlet side shut-off valve is closed or clogged.
- There is air trapped in the pump housing (turn the pump on and off several times to see if the air pocket can be "bumped" out of the pump and if not, then open the hose bib for manual venting).
- There is debris blocking the rotor.
- The rotor bearing has worn due to dry running causing the rotor to wobble during operation.
- If the return line connects to the cold water supply at the top of water heater, the warm water may be creating back pressure in the cold supply line. If so, add a check valve on the cold supply line above the return line tee connector.

Pump Operating Intermittently or Not at All:

- No power to the pump.
- There is debris or foreign matter in the pump.
- The thermostat is not functioning properly (see page 6 on thermostat operation). If wanted, the thermostat may be easily disconnected. Contact the Laing factory for details.

Water Taking Too Long to Get to Faucet:

- The hot water supply from the water heater is exhausted.
- The faucet involved may be on a branch line off the main hot water supply line in which case there may be a slightly longer wait for hot water to arrive than at faucets directly off the main supply line.
- The check valve is installed backwards.
- The pump is not operating.
- The timer is not operating properly.

Signs of Dry Run:

Dry run results from inadequate water supply to the pump, which prevents lubrication of the bearing ball. It may be caused by operating the pump without water in the plumbing lines, which may occur with frozen pipes, or by failing to turn the pump off when the system is drained for servicing. It can also occur as the result of large air bubbles collecting in the pump housing and preventing the flow of water over the bearing ball. If the problem is air in the system, check that the air vent is functioning, that the system is properly purged of air and that the pump and various system components are installed in accordance with the diagrams shown on page 3.



Laing Thermotech, Inc.

830 Bay Boulevard, Suite 101, Chula Vista, CA 91911

Phone: (619) 575-7466 Fax: (619) 575-2739

www.lainginc.com • www.autocirc.com

IM-16 (09/05)